



Programmable Logic Controller

XGB U

Ultimate Performance
Universal IoT
User Oriented



Programmable Logic Controller

XGB U

What you have dreamed of, we make happen.

XGB U sets new standards in **Ultimate performance** with its many innovations
IoT (Internet of Things) making the smart factory a reality.
XGB-U, the **User Oriented Controller**

Built-in analog type

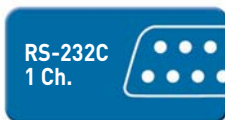

* The actual size of the product

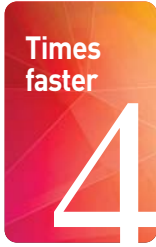

CPU Processing Speed

4 times faster CPU speed than XGB-E

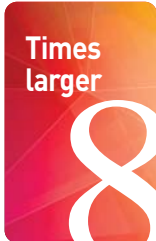
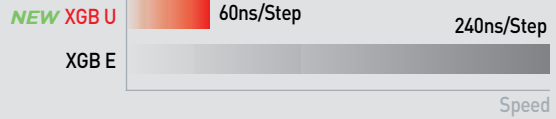

Program Capacity

8 times larger memory capacity than XGB-E

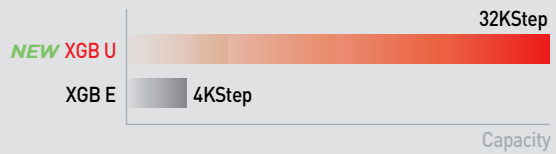

Built-in positioning type

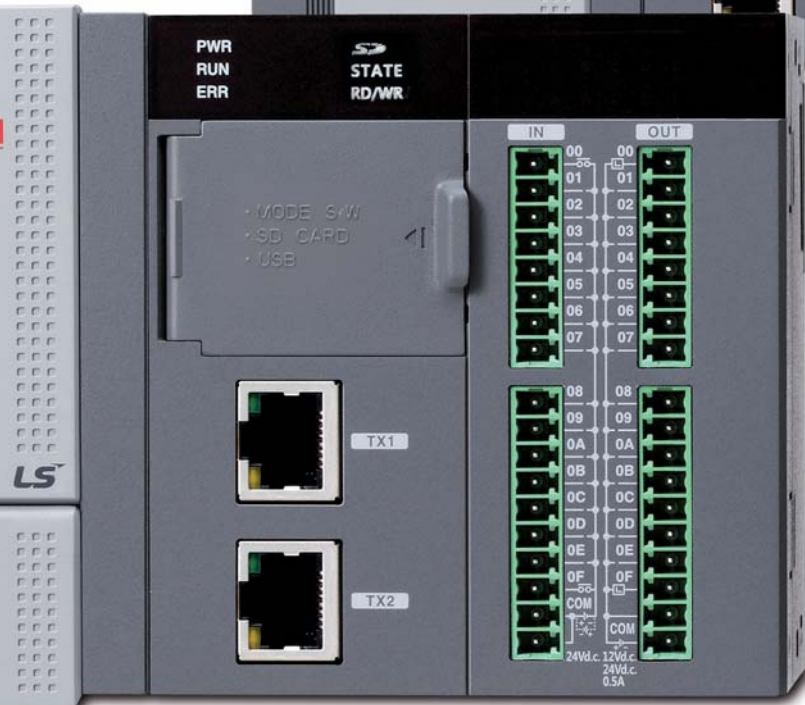
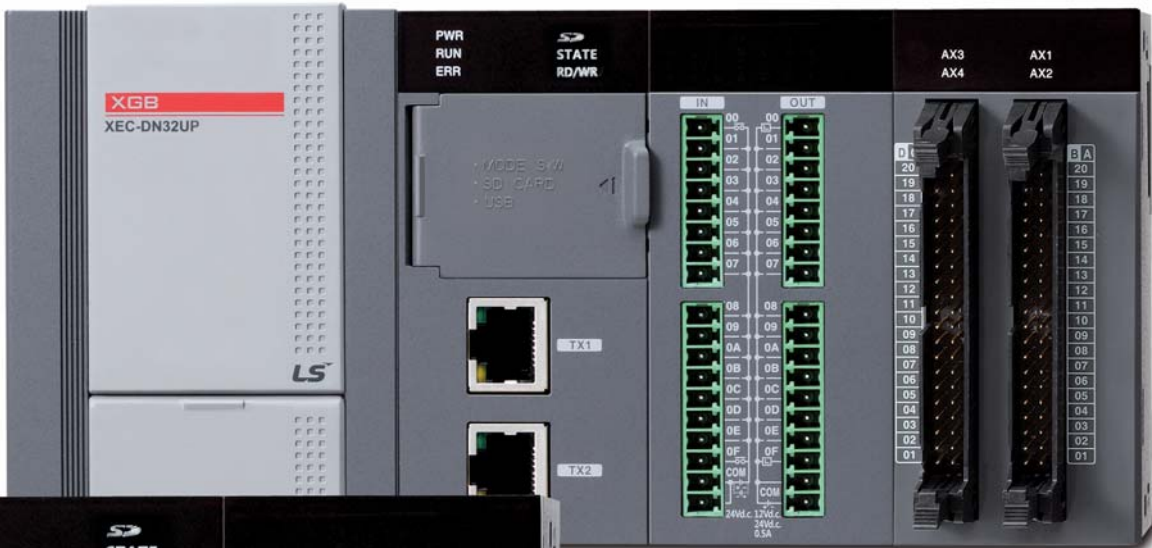

Standard type

Various Expansion

- Compatible with XGB expansion modules
- Max. 2 High speed backplane expansion modules
- Max. 10 expansion modules
- Max. 352 I/O points
- Expansion I/O module
 - DC24 input, Transistor output, Relay output
- Special module
 - Analog input, Analog output, RTD, Thermocouple, High-speed counter, Positioning (Line drive 2 axes, EtherCAT network 8 axes)
- Communication modules
 - RS-232C, RS-422/485, Ethernet, CANopen (Master/Slave), Profibus-DP (Master/Slave), DeviceNet (Slave), EtherNet/IP, RAPIenet

You will experience utmost efficiency for your applications

Dual Port Ethernet

- 2 ports unmanaged Ethernet switch support
- Cost saving through simple wiring
- FTP server support (Data logging)

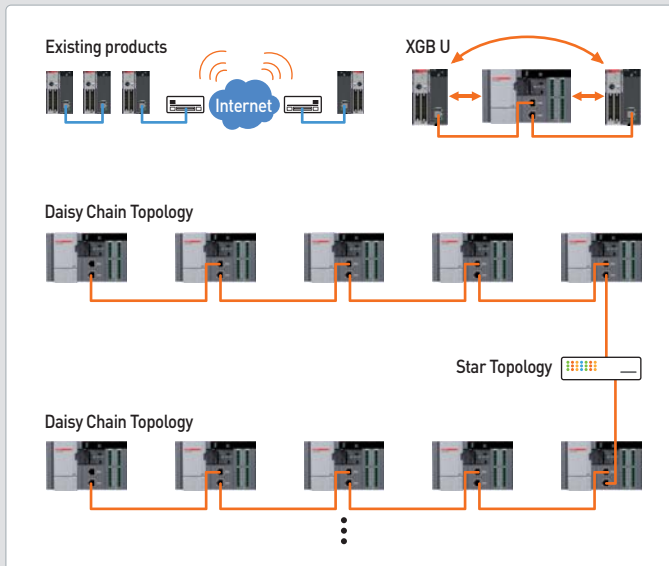

Positioning

- 4 axes built-in Positioning line drive pulse output (XEC/XBC-DN32UP)
- Position control, speed control, position/speed control, speed/position control, linear/circular/helical interpolation, CAM control

Web Server

- Monitoring of PLC information and data through web browser (PLC basic info., module info., diagnosis, device monitoring, flag monitoring, data log file download, O/S update, ladder program update, etc.)
- Time synchronization by setting basic parameters (SNTP: Simple Network Time Protocol)
- Email service through commercial email (SMTP: Simple Mail Transfer Protocol)

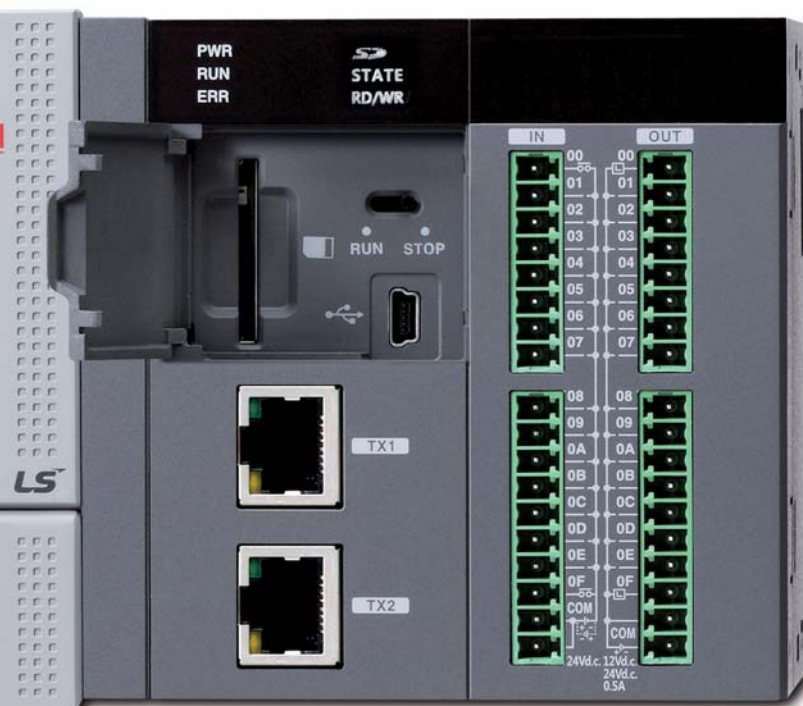
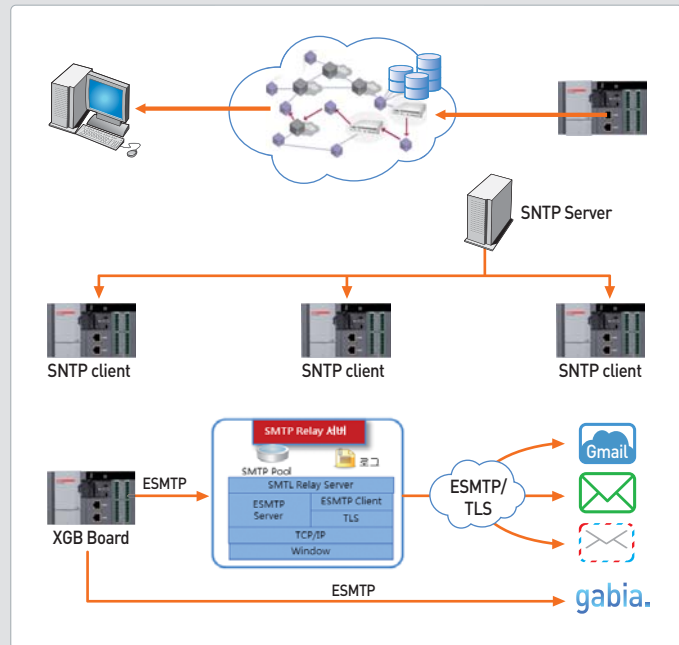

Standard type

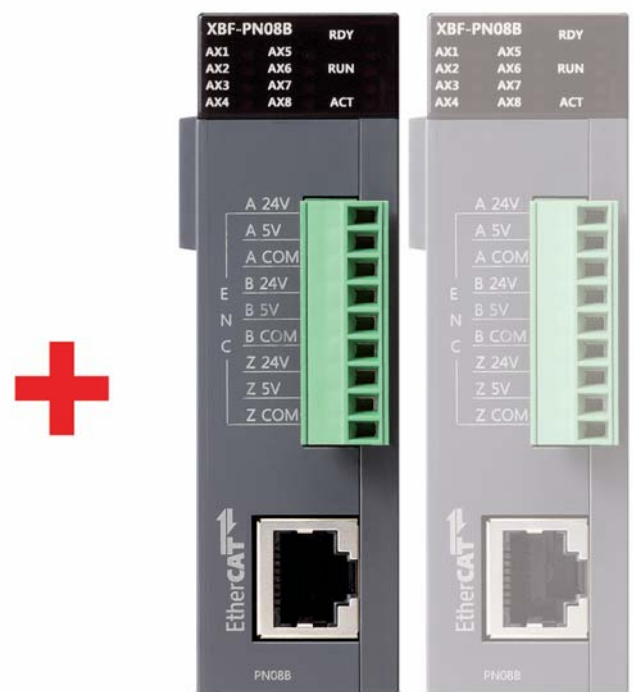

High speed interface module: Max. 2 stages

with U's outstanding features

Data Log

- Easy parameter set up for [General save], [Trigger save], [Event save] without instruction
- 16GB of operation data storable
- Additional function
 - SD memory format, FTP link, Diagnosis, sending E-mail
 - PLC program upload/download
 - O/S update

Expansion

- Max. 10 expansion modules
- Max. 2 High speed backplane modules
- Max. 2 Communication modules

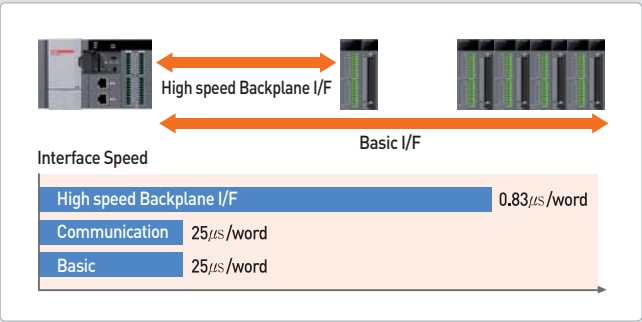

Analog Input/Output

- Built-in analog function (XEC/XBC-DN32UA)
- 4ch. Input, Output
- Resolution: 1/16,000, conversion speed: 0.5ms/ch

EtherCAT Positioning Module (XBF-PN08B)

- High speed backplane transmission through USB host function
- Standard EtherCAT protocol, CoE (CANopen over EtherCAT)
- 1ms communication cycle
- Max. 8 axes servo driver control
- 2-8 axes linear interpolation, 2 axes circular interpolation, 3 axes helical interpolation, 8 types of CAM data to control CAM

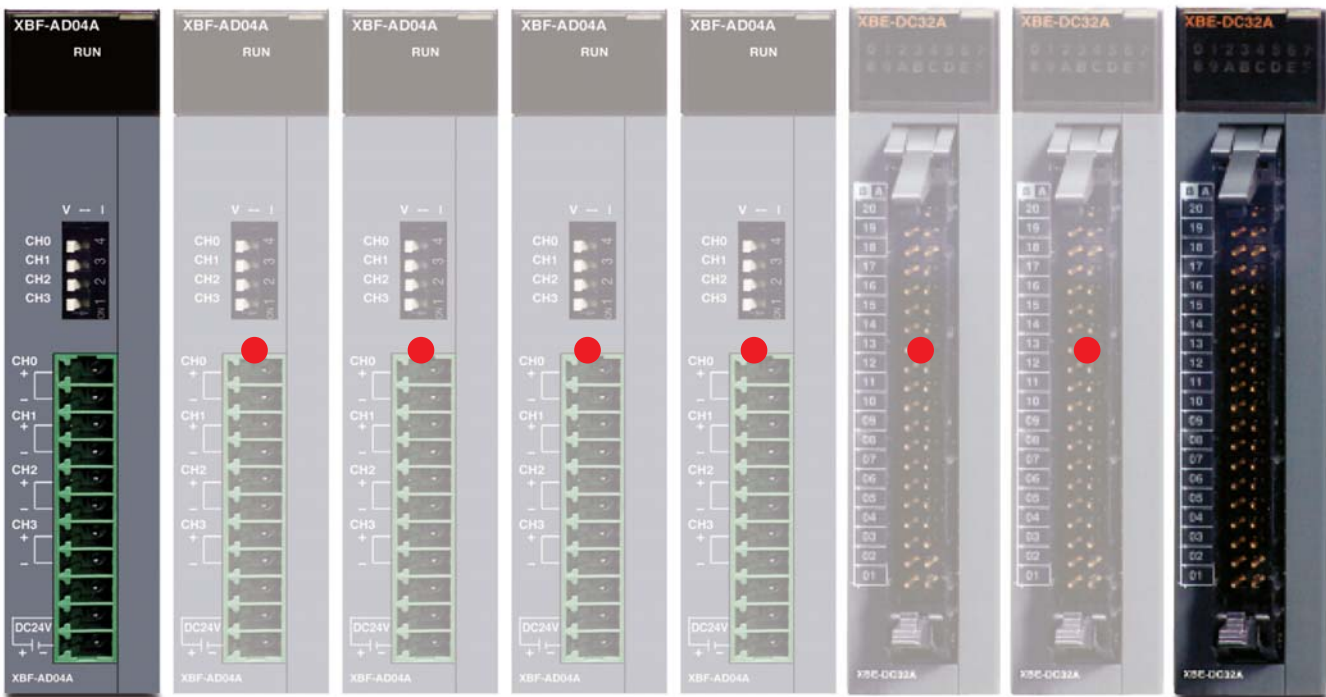
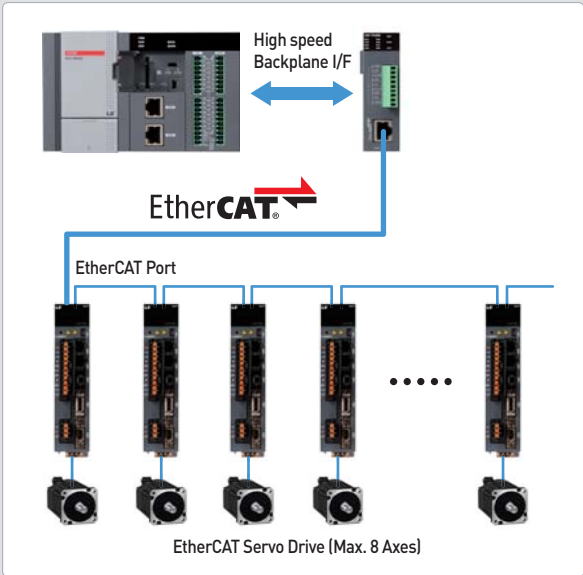

High speed interface module + Basic expansion module: Max. 10 stages

Performance Specification

Item	XBC-DN32U	XBC-DR28U	XBC-DN32UA	XBC-DR28UA	XBC-DN32UP	XBC-DR28UP
Programming language	Ladder Diagram, Instruction List					
Processing speed (Basic instruction)	60ns/step					
Program capacity	32Kstep					
Max. I/O points	Main+Expansion 10 stages					
Built-in	High-speed counter	100kHz*8ch				
	Data log	Memory: SD [16GB], File format: CSV				
	Analog	-	AD 4Ch, DA 4Ch		-	
	Positioning	-	-		2Mpps*4axes	
	Ethernet	10Mbps/100Mbps, 2 Port				
Data area	P	P00000 ~ P2047F(32,768 point)				
	M	M00000 ~ M2047F(32,768 point)				
	K	K00000 ~ K8191F(131,072 point)				
	L	L00000 ~ L4095F (65,536 point)				
	F	F00000 ~ F2047F (32,768 point)				
	T	100ms, 10ms, 1ms: T0000 ~ T2047 (2,048 point)				
	C	C000 ~ C2047 (2,048 point)				
	S	S00.00 ~ S127.99				
	D	D00000 ~ D19999(20000word)				
	U	U00.00 ~ U0B.31 (384 word)				
Z	Z000~Z127 (128 word)					
N	N0000~N10239(10,240 word)					
Operation mode	RUN, STOP, DEBUG					
Self-diagnosis function	Detects errors of scan time, memory, I/O and power supply					
Program port	USB 1 channel					
Back-up method	Latch area setting in basic parameter					
Internal consumption current	700mA	990mA	780mA	1,040mA	1,250mA	1,550mA
Weight	571g	630g	683g	732g	673g	722g

Item	XEC-DN32U	XEC-DR28U	XEC-DN32UA	XEC-DR28UA	XEC-DN32UP	XEC-DR28UP	
Programming language	Ladder Diagram, Instruction List						
Processing speed (Basic instruction)	60ns/step						
Program capacity	32Kstep						
Max. I/O points	352	348	352	348	352	348	
Built-in	High-speed counter	100kHz*8ch					
	Data log	Memory: SD [16GB], File format: CSV					
	Analog	-	AD 4Ch, DA 4Ch		-		
	Positioning	-	-		2Mpps*4axes		
	Ethernet	10Mbps/100Mbps, 2 Port					
Data area	Symbolic variable(A)	64KB (Retain setting available)					
	Input variable(I)	2KB					
	Output variable(O)	2KB					
	Direct variable	M	32KB (Retain setting available)				
		R	32KB*2 blacks				
		W	64KB				
	Flag variable	F	4KB				
		K	16KB				
		L	8KB				
		U	768Byte				
N		20KB					
Operation mode	RUN, STOP, DEBUG						
Self-diagnosis function	Detects errors of scan time, memory, I/O and power supply						
Program port	USB 1 channel						
Back-up method	Latch area setting in basic parameter						
Internal consumption current	700mA	990mA	780mA	1,040mA	1,250mA	1,550mA	
Weight	571g	630g	683g	732g	673g	722g	

LSIS Co., Ltd.

HEAD OFFICE

LS Tower, 127, LS-ro, Dongan-gu, Anyang-si, Gyeonggi-Do, 431-848, Korea

■ Southeast Asia	+82-2-2034-4888	cshwang@lsis.com (Charles Hwang)
■ Europe	+82-2-2034-4676	sukyong@lsis.com (Brian Choi)
■ Turkey/Israel/CIS	+82-2-2034-4879	dkimc@lsis.com (Daniel Kim)
■ Oceania	+82-2-2034-4394	kacho@lsis.com (Kendra Cho)
■ North/Latin America	+82-2-2034-4286	hkchung@lsis.com (Hank Raul Chung)
■ Southwest Asia/Africa	+82-2-2034-4467	myleed@lsis.com (Henry Lee)
■ Middle East	+971-4-886-5360	khchoi1@lsis.com (Lambert Choi)

Overseas Subsidiaries

- LSIS USA Inc. Chicago, U.S.A.
2000 Millbrook Drive, Lincolnshire, Chicago, IL 60069, United States
Tel : 847-941-8240 Fax : 847-941-8259
- LSIS(ME) FZE Dubai, U.A.E.
LOB 19-205, JAFZA View Tower, Jebel Ali Free Zone, Dubai, United Arab Emirates
Tel : 971-4-886-5360 Fax : 971-4-886-5361

© 2014. LSIS Co., Ltd. All Rights Reserved.

- LSIS(Dalian) Co., Ltd. Dalian, China
No. 15, Liaohexi 3-Road, Economic and Technical Development Zone, Dalian 116600, China
Tel : 86-411-8730-7510 Fax : 86-411-8730-7560
- LSIS(Wuxi) Co., Ltd. Wuxi, China
No. 1, Lexing Road, Wuxi National High & New Tech Industrial Development Area, Wuxi214028, Jiangsu, P.T.China
Tel : 86-510-8534-6666-8005 Fax : 86-510-8534-4078
- LS Hukai Electric(Hubei) Co., Ltd. Hubei, China
No. 100, Tanjiahe Road, Dianjun District, Yichang City, Hubei Province, 443004, China
Tel : 86-717-667-7339 Fax : 86-717-667-7559
- LS-VINA Industrial Systems Co., Ltd. Hanoi, Vietnam
Nguyen Khe, Dong Anh, Hanoi, Vietnam
Tel : 84-4-6275-8055 Fax : 84-4-3882-0220
- LSIS Europe B.V. Netherlands
1st. Floor, Tupolevlaan 48, 1119NZ, Schiphol-Rijk, The Netherlands
Tel : 31-20-654-1420 Fax : 31-20-654-1429
- LSIS Japan Co., Ltd. Tokyo, Japan
Tokyo Club Building 13F, 2-6, Kasumigaseki 3-chome, Chiyoda-ku, Tokyo, 100-0013
Tel : 81-3-6268-8241 Fax : 81-3-6268-8240

Specifications in this catalog are subject to change without notice due to continuous product development and improvement.